

DAIKIN AC[®]
absolute comfort

VRV-WIII[®]

VRV-WIII

WATER-COOLED



WATER-COOLED ■ COMMERCIAL ■ RENOVATION ■ NEW CONSTRUCTION

The Water-Cooled Generation

VRV-WIII systems are equivalent to 4-pipe chilled water systems, but also offer a viable alternative to Water-Source Heat Pump solutions. Each connected indoor unit can provide heating and cooling independently to suit zone requirements making these systems suitable for both open plan, or cellular applications with different operation requirements.

VRV-WIII Features and Benefits

Compact and lightweight

Industry leading compact lightweight casing
Height: 39-3/8", Weight: 330 lbs. Install in a plant room, double-decker style if needed.

Large capacity (6 to 21-Ton)

Larger single system capacity ensures wider application range for satisfying floor-by-floor loads of commercial buildings.

Lower condenser water temperature

Continuous operation at 59°F entering condenser water temperature; intermittent operation as low as 50°F thus suitable for low ambient temperature.



Water side:
Connecting to cooling tower and/or boiler combination or set up as geothermal

Refrigerant side:
Connects to Daikin's lineup of VRV indoor units



The VRV-WIII design is based on a **modular design** concept. It is composed of unified condensing units that require simply connecting a 2-pipe refrigerant network for heat pump applications or a 3-pipe refrigerant network for heat recovery applications. All water-cooled condensers are of the same dimensions, and are available in 6-Ton and 7-Ton. This is a simple system that allows manifolding together up to 3 condensers to form one system of up to 21-Ton (252 MBH). The condensers are designed for internal mounting only.

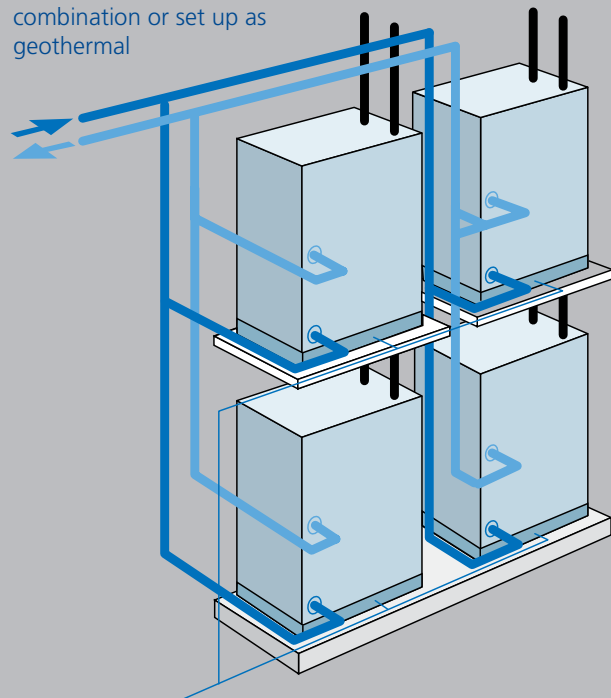

The condensers are smaller and can be stacked, reducing the installation space and increasing the customer's usable square footage.

Why Select a VRV-WIII System?

The top 5 reasons that make the solution a perfect fit

- 1 The efficiency and capacity of air-cooled systems reduce with extreme ambient conditions, causing systems to be oversized and increasing initial cost.
- 2 Extreme piping lengths cause a capacity reduction; positioning VRV-WIII floor-by-floor reduces the capacity reduction and improves the efficiency of the system.
- 3 Buildings with diverse loads will recover energy through the VRV-WIII system's water loop, enhancing overall efficiency.
- 4 Utilizing an existing condenser loop and associated heat rejection/injection reduces initial costs.
- 5 Where geothermal efficiencies and benefits are desired, VRV-WIII is geothermal ready as standard.

New Construction

The VRV-WIII provides an energy efficient solution anywhere that could use a water-cooled chiller or replacing Water-Source Heat Pump design by enabling them to afford the **water-cooled chiller** benefits. It is especially true for high-rise buildings such as:

- Condos
- Offices
- Medical Centers
- Schools
- In northern climates, VRV-WIII eliminates the low ambient heating and cooling concerns
- Large building tenant fit outs: with VRV-WIII, the floors can now be leased as they are being completed in sequence
- Add on new-build to existing campuses
- Geothermal applications

Retrofit

Adding on to an existing water-cooled system or solving problem areas with VRV-WIII becomes a very easy, cost effective solution for applications such as hospitals, large business campuses, universities, office buildings, and factories.

Also, the VRV-WIII can take advantage of an application with an existing 2-pipe chiller/boiler system with a condenser water loop.

New water-cooled solutions for all

The general consensus was that water-cooled is only suitable for larger projects but that line of thinking is obsoleted with the VRV-WIII. The VRV-WIII proves itself a very competitive upgrade when replacing noisy Water-Source Heat Pump or rooftops with VAVs.

VRV-WIII Unified Condensing Unit - Heat Recovery or Heat Pump from One Unit

- Connect two pipes = Heat Pump
- Connect three pipes + Branch Selector boxes = Heat Recovery
- The water loop can be designed for maximum anticipated installed load.

Benefits

- Lower initial cost for the developer/builder
- Client or developer can add air conditioning to match load requirements
- No rebalancing of water systems if commissioning valves are installed on each floor
- Connects to the full suite of advanced Daikin control solutions including Intelligent Touch Controller and I-Manager III
- Can be integrated to open protocol building management systems via the Daikin BACnet® and LonWorks® interfaces

Outstanding performance for cold climate applications

VRV-WIII Condensing Units RWEYQ

Utilizing VRV-WIII eliminates the ambient operation range limitation and the associated capacity and efficiency reduction (up to 30%) of air-cooled systems. This solution can result in smaller capacity equipment (reducing initial costs) and eliminates the need for a secondary heating source at the indoor units and their associated fuel/power supply.

Minimal to no ventilation is required for the heat rejection of the condensers which reduces installation cost (the installed location must be kept between 32°F and 104°F).

VRV-WIII connects to a closed-loop cooling tower and boiler, or in a geothermal configuration.

The VRV-WIII (unified heat pump or heat recovery condensing unit) allows for continuous operation even in cold climates delivering comfortable heating performance with no defrost. The system's brazed plate heat exchanger can tolerate water pressure up to 285 psi (or 640ft. of head) and has modular units that can be interconnected to make combinations of up to 21-Tons.



Standard VRV-WIII Specification

Specification	Application Rules
Water Flow Rate (minimum)	16.4 – 39.5 (13.2) gpm [62 – 150 (50) l/m]
Water Temp Range Cooling (intermittent)	59 – 113°F (50°F) [15 - 45°C]
Water Temp Range Heating (intermittent)	59 – 113°F (50°F) [15 - 45°C]
Water Temp Range Simultaneous Cooling & Heating (intermittent)	59 – 113°F (50°F) [15 - 45°C]
Glycol Allowance	0 – 40%
Glycol Type	Propylene / Ethylene
Connection Ratio	50 – 130%

VRV-WIII Geothermal Configuration

With addition of the newly developed VRV-WIII geothermal control logic, the operation range can now be extended to as low as 14°F (-10°C) entering water temperature (EWT) in heating. Contact your local Daikin office for more details.

Geothermal applications are available for single module systems.

Geothermal Enhanced VRV-WIII Specification

Specification	Application Rules
Water Flow Rate	21 – 40 gpm [80 – 150 l/m]
Water Temp Range Cooling (intermittent)	50 – 113°F (43°F) [6 - 45°C]
Water Temp Range Heating	14 – 113°F [-10 - 45°C]
Water Temp Range Simultaneous Cooling & Heating (intermittent)	50 – 113°F (43°F) [6 - 45°C]*
Glycol Requirement	30 – 45%**
Glycol Type	Ethylene
Connection Ratio	50 – 100%

* EWT in simultaneous heating and cooling operation can be lower than 43°F if the condenser is in heating dominant heat recovery operation (contact your local Daikin office for further details)

** EWT operation range is limited to 23°F (-5°C) with 30% glycol, 40-45% glycol must be used with water temperatures below 23°F down to a limit of 14°F



Water-Side Infrastructure & Components

- A water loop system is routed around the building, either vertically or horizontally.
- Heat injection (boilers) and rejection (cooling tower or dry coolers) are required to ensure that the water loop stays between the required design conditions of 50 and 113°F.
- Can connect to geothermal water loop as standard
- VRV-WIII condensers are connected to the water loop and the connecting refrigerant circuit serves indoor units the same as any air-cooled VRV system.
- The following water side components are required:
 - ◆ Strainer (mandatory – supplied with each condensing unit)
 - ◆ Flow switch or differential pressure switch (Essential)
 - ◆ Thermostat (for water temperature)
 - ◆ Circulation pumps
 - ◆ Adjustable flange

Example of layout when used in combination with boiler and cooling tower

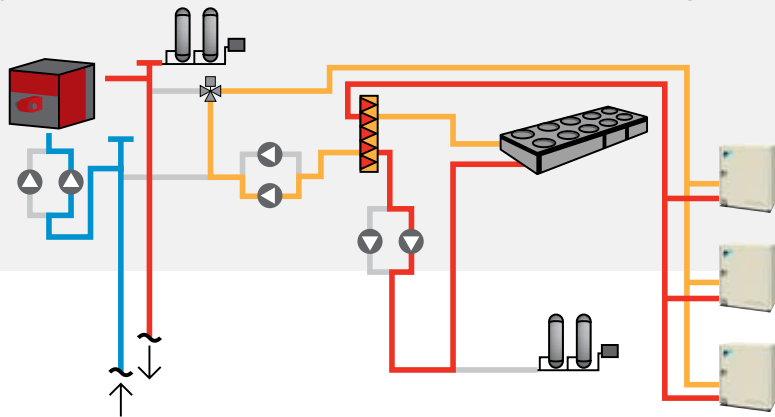

Pump connections and interlock function

Pump Connections

It is possible to interlink the operation of the water circulation pumps with the operation of the VRV-WIII condensing unit.

- A set of terminals are provided on the condensing unit terminal X2M rated at 240VAC, up to 0.5A.
- This terminal can be used to power a relay to start the pumps.
- In manifolded condensing unit installations (e.g. RWEYQ216PTJU), a group control PCB (DTA104A62) can be used because a set of terminals on this accessory provides the pump operation signal when any condensing unit is in operation. The X2M terminals will not be used in this instance.

Interlock Circuit

- An interlock circuit needs to be connected to the terminals of X3M of every condensing unit to allow the system to operate. This interlock can be a flow or differential pressure switch (to ensure water is flowing before operation starts). Terminals X3M are rated at 15VDC 1mA.
- In manifolded condensing unit installations (e.g. RWEYQ216PTJU), by installing a group control PCB, DTA104A62, the flow switch needs to be connected to the master condensing unit only.

Minimizing Energy Consumption

Energy Savings Impact

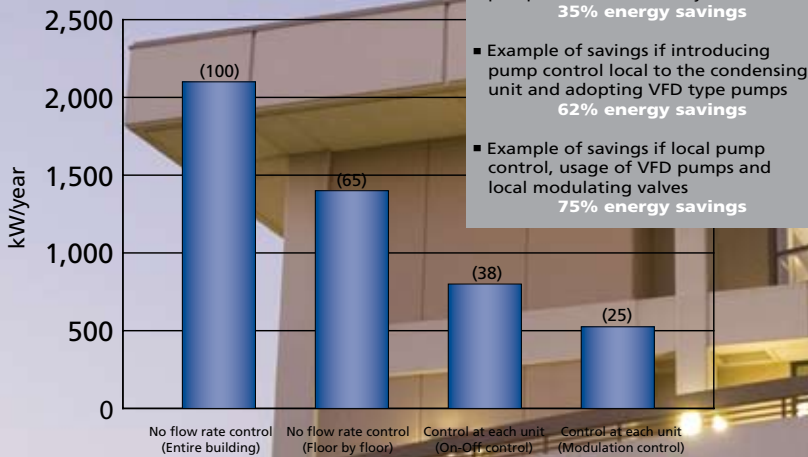

Did you know?

VRV-WiII systems placed in service during the tax year that was acquired after October 3, 2008 may be eligible for a geothermal system 10% investment US federal tax credit when using the ground or ground water as a thermal energy source. For the tax credit details and instructions for claiming the credit, please see IRS Form 3468.

High energy efficiencies result from 2-stage heat recovery

VRV-WiII benefits from a 2-stage heat recovery capability. The first stage (stage 1) is achieved within the refrigerant system and applies to heat recovery units only. Heat exhausted from indoor units in cooling mode is merely transferred to units in areas requiring heating, maximizing energy efficiency and reducing electricity consumption.

Heat recovery also available on heat pump units through the water loop

Second stage (stage 2) heat recovery is achieved within the water loop between the water-cooled condensing units. Two-stage heat recovery substantially improves efficiency and represents an ideal solution to the requirements of modern office buildings, in which some areas require cooling even in winter, depending on the degree of sunshine at the time, the number of individuals in the room, and the application.

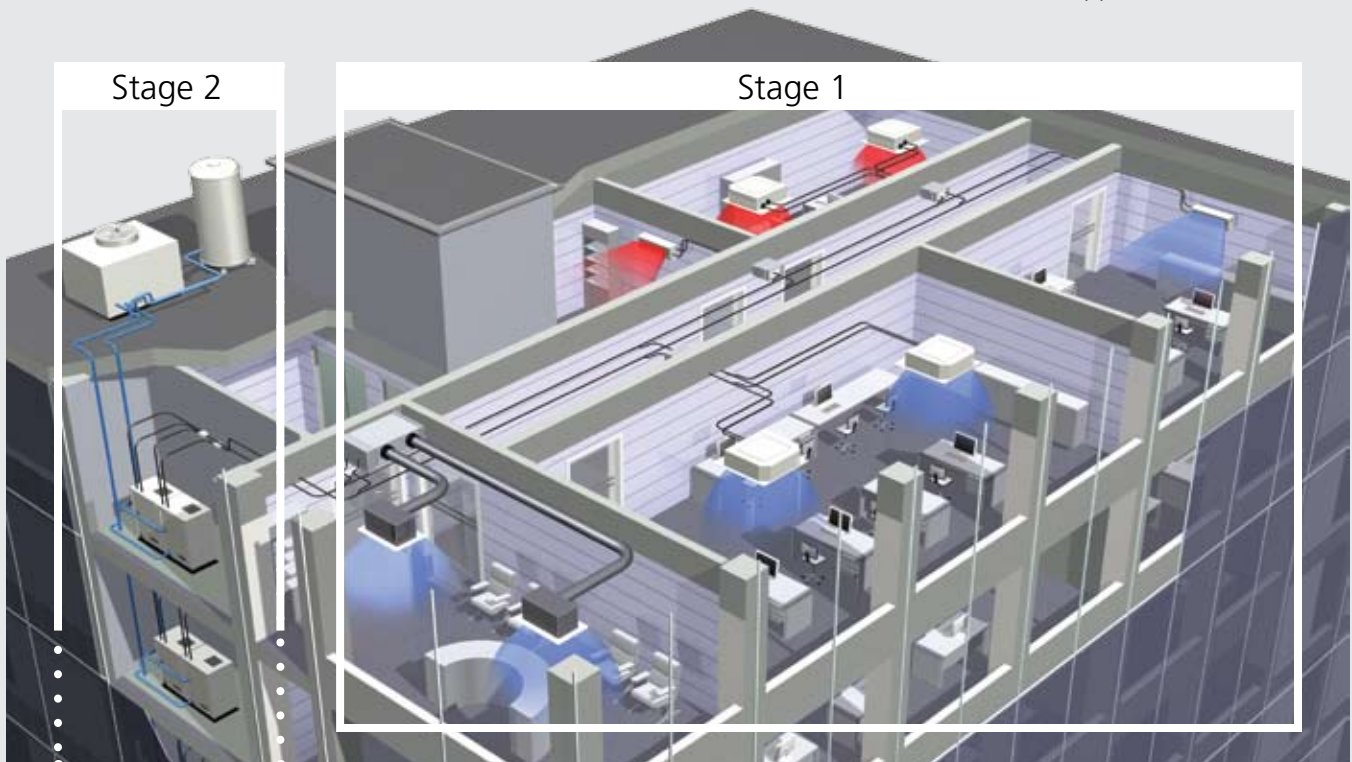

Versatile Piping Design

Versatile water piping

VRV-WIII uses water as its heat source, so it is optimal for large buildings, including tall, multi-story buildings, because the system can tolerate water pressure of up to 285 psi (or 640 ft. of head).

Furthermore, if the currently installed heat source's water temperature is between 50°F and 113°F, it may be possible to use the existing water pipe work and heat source. This alone makes it an ideal system solution for building refurbishment projects.

Because the system is water-cooled, outdoor air temperature does not affect its heating capacity. In addition, water-cooling means no defrost operation is required, and the resultant rapid start-up time assures quick and comfortable heating, even in cold environments.

Long refrigerant piping length

Considerable flexibility is available within the refrigerant circuit since up to 980ft. actual piping length and 164ft. (if the VRV-WIII condensing unit is above the indoor unit) in height can exist between the VRV-WIII condensing units and indoor units. Water piping does not intrude in the occupied spaces, so there are no potential leakage problems.

The VRV-WIII now allows for a functional, easy-to-install water-cooled solution into smaller applications. The systems fit very well in tall/large buildings however it is also a perfect fit for a smaller job where the installation of a chiller is cost prohibitive.

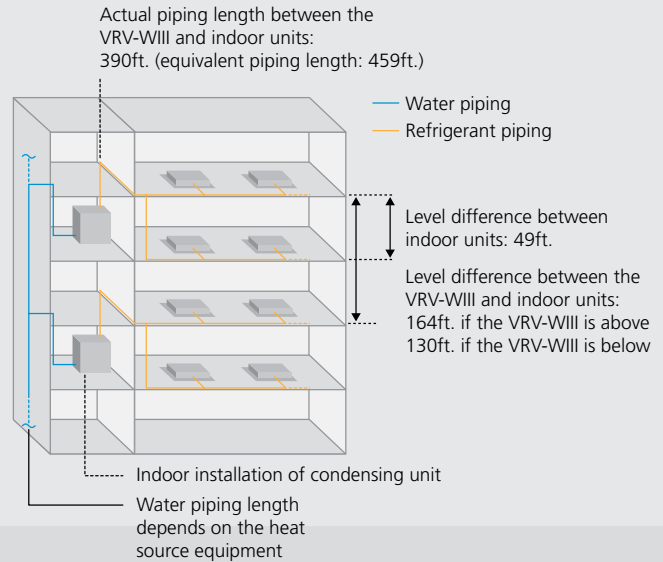

































































Refrigerant piping specifications	Ft.
Linear piping between condensing unit and furthest located fan coil unit (equivalent)	390 (459)
Total "one-way" piping in the complete piping network	980
Vertical (height) separation between the condensing unit and the fan coil units (if condensing unit is below)*	164 (130)
Vertical (height) separation between fan coil units	49
Linear piping between 1st REFNET and furthest located fan coil unit	130

*For geothermal applications, if the condenser is lower than the indoor units, the maximum vertical separation is 65 ft.



VRV Indoor Units

Indoor Type		Capacity Range												
		MBH	7.5	09	12	18	24	30	36	42	48	54	72	96
		Tons	0.6	0.75	1	1.5	2	2.5	3	3.5	4	4.5	6	8
Ducted	Vertical air handling unit (horizontal right configuration is possible)	FXTQ_PAVJU 												
	DC ducted concealed ceiling (medium static)	FXMQ_PVJU 												
	Concealed ceiling unit (medium static)	FXMQ_MVJU 												
	Slim duct built-in concealed ceiling unit	FXDQ_MVJU 												
Duct-free	Round flow ceiling mounted cassette	FXFQ_PVJU 												
	2' x 2' 4-way ceiling mounted cassette	FXZQ_M7VJU 												
	Wall mounted unit	FXAQ_MVJU 												
	Ceiling suspended unit	FXHQ_MVJU 												
	Floor standing unit	FXLQ_MVJU 												
	Concealed floor standing unit	FXNQ_MVJU 												
Ventilation	100% Outside Air Processing Unit	FXMQ_MFVJU 												

-  Available (11 types, 51 models)
-  Condensate pump standard on model
-  Outside air connection possible on model

VRV-WIII Specifications

Single module system

VRV-WIII - Unified Heat Pump and Heat Recovery		6-Ton		7-Ton		
Model	Name	RWEYQ72PTJU		RWEYQ84PTJU		
Performance	Cooling Capacity ¹	Btu/h	72,000		84,000	
	Rated Full Load EER*		15.3		13.7	
	Cooling Input Power	kW	4.2		5.6	
	Heating Capacity ²	Btu/h	81,000		94,000	
	Rated Full Load COP*		5.3		4.7	
	Heating Input Power	kW (Btu/h)	4.0 (13,648)		5.4 (18,425)	
	Power	V/Ph/Hz	208-230/3/60		208-230/3/60	
	Sound Pressure Level @ 3ft.	dB(A)	50		51	
Refrigerant Piping	System Configuration		Heat Pump	Heat Recovery	Heat Pump	Heat Recovery
	Liquid Pipe (Main Line)	in.	3/8	3/8	3/8	3/8
	Suction Gas Pipe (Main Line)	in.	N/A	3/4	N/A	7/8
	Discharge Gas Pipe (Main Line)	in.	3/4	5/8	7/8	3/4
	Vertical Pipe Length (if unit is below FCU)	ft.	164 (130)		164 (130)	
	Actual Pipe Length (Equivalent Length)	ft.	390 (459)		390 (459)	
	Total Pipe Length	ft.	980		980	
Connection Ratio	Standard Connectable Indoor Unit Ratio (geothermal)	%	50 - 130 (50 - 100)		50 - 130 (50 - 100)	
	Maximum Number of Indoor Units	Qty.	12		14	
Water Side	BPHE Inlet Pipe (Female Thread)	in.	1 1/4FPT		1 1/4FPT	
	BPHE Outlet Pipe (Female Thread)	in.	1 1/4FPT		1 1/4FPT	
	Drain Pipe (Female Thread)	in.	1/2FPS		1/2FPS	
	Maximum System Water Pressure (BPHE)	psi	285		285	
	Inlet Water Temperature Range (intermittent)	°F	59 - 113 (50)		59 - 113 (50)	
	Recommended Inlet Water Flow Rate per Module (min.)	gpm	16.4 ~ 39.5 (13.2)		16.4 ~ 39.5 (13.2)	
Unit	Weight	lbs.	330		330	
	Dimensions (H x W x D)	in.	39 3/8 x 30 3/4 x 21 11/16			
Electrical	Voltage Range (min.-max.)	V	187-253		187-253	
	Maximum Overcurrent Protection (MOP)	A	40.0		40.0	
	Minimum Circuit Amps (MCA)	A	22.4		22.4	
	Compressor Rated Load Amps (RLA)	A	11.6		15.4	
Compressor	Compressor Type		Daikin G-Type Scroll		Daikin G-Type Scroll	
	Compressor Set-up		1 INV		1 INV	
	Compressor Capacity Control	%	23 - 100		23 - 100	

1 Indoor temp. : 80°FDB, 67°FWB/inlet water temp. : 85°F/outlet water temp. : 95°F Equivalent piping length : 25ft, level difference : 0ft.

2 Indoor temp. : 70°FDB, 60°FWB/inlet water temp. : 70°F/Equivalent piping length : 25ft, level difference : 0ft.

*The tested system EER and COP values reflect "full load" efficiency only and are the results from testing to the "Alternate Test Method" (ATM) guidelines provided by the U.S. Department of Energy (DOE) in the Federal Register / Vol. 74, No. 68 / Friday April 10, 2009 / Notices / Pages 16373 - 16377. All tested values surpass the minimum efficiency levels regulated in the DOE Code of Federal Regulation 10 CFR Ch. II § 431.97.

Testing was performed at full load capacity with a ducted indoor unit configuration to determine only the Energy Efficiency Ratio (EER) and Coefficient Of Performance (COP) as specified from the DOE in the ATM guidelines. A VRV®-WIII system is a system that is constantly modulating its operation, via its intelligent Inverter Compressor Technology and Electronic Expansion Valves, to satisfy the ever changing load requirements of the buildings they serve. Although EER and COP are a common metric for comparing efficiencies, they do not fully qualify the expected performance as the majority of operating hours are in part load operation. However, at this time no official testing and rating program to quantify the part load efficiency (such as iPLV) of a VRV-WIII system is recognized by the DOE.



ABSOLUTE COMFORT

10

DAIKIN AC



VRV-WIII Specifications

Double module system

VRV-WIII - Unified Heat Pump and Heat Recovery			12-Ton		14-Ton	
Model	Name		RWEYQ144PTJU		RWEYQ168PTJU	
	Combination		2 x RWEYQ72PTJU		2 x RWEYQ84PTJU	
Performance	Cooling Capacity ¹	Btu/h	144,000		168,000	
	Rated Full Load EER*		15.3**		13.7**	
	Cooling Input Power	kW	8.4		11.2	
	Heating Capacity ²	Btu/h	162,000		189,000	
	Rated Full Load COP*		5.3**		4.7**	
	Heating Input Power	kW (Btu/h)	8.0 (27,296)		10.8 (36,850)	
	Power	V/Ph/Hz	208-230/3/60		208-230/3/60	
	Sound Pressure Level @ 3ft.	dB(A)	53		54	
Refrigerant Piping	System Configuration		Heat Pump	Heat Recovery	Heat Pump	Heat Recovery
	Liquid Pipe (Main Line)	in.	1/2	1/2	5/8	5/8
	Suction Gas Pipe (Main Line)	in.	N/A	1 1/8	N/A	1 1/8
	Discharge Gas Pipe (Main Line)	in.	1 1/8	7/8	1 1/8	7/8
	Vertical Pipe Length (if unit is below FCU)	ft.	164 (130)		164 (130)	
	Actual Pipe Length (Equivalent Length)	ft.	390 (459)		390 (459)	
	Total Pipe Length	ft.	980		980	
Connection Ratio	Standard Connectable Indoor Unit Ratio	%	50 - 130		50 - 130	
	Maximum Number of Indoor Units	Qty.	20		20	
Water Side	BPHE Inlet Pipe (Female Thread)	in.	2 x (1 1/4FPT)		2 x (1 1/4FPT)	
	BPHE Outlet Pipe (Female Thread)	in.	2 x (1 1/4FPT)		2 x (1 1/4FPT)	
	Drain Pipe (Female Thread)	in.	2 x (1/2FPS)		2 x (1/2FPS)	
	Maximum System Water Pressure (BPHE)	psi	285		285	
	Inlet Water Temperature Range (intermittent)	°F	59 - 113 (50)		59 - 113 (50)	
	Recommended Inlet Water Flow Rate per Module (min.)	gpm	16.4 ~ 39.5 (13.2)		16.4 ~ 39.5 (13.2)	
Unit	Weight	lbs.	2 x 330		2 x 330	
	Dimensions (H x W x D)	in.	39 3/8 x (30 3/4 x 2) x 21 11/16			
Electrical	Voltage Range (min.-max.)	V	187-253		187-253	
	Maximum Overcurrent Protection (MOP)	A	40 + 40		40 + 40	
	Minimum Circuit Amps (MCA)	A	22.4 + 22.4		22.4 + 22.4	
	Compressor Rated Load Amps (RLA)	A	11.6 + 11.6		15.4 + 15.4	
	Compressor Type		Daikin G-Type Scroll		Daikin G-Type Scroll	
Compressor	Compressor Set-up		1 INV + 1 INV		1 INV + 1 INV	
	Compressor Capacity Control	%	11 - 100		11 - 100	

1 Indoor temp. : 80°FDB, 67°FWB/inlet water temp. : 85°F/outlet water temp. : 95°F Equivalent piping length : 25ft, level difference : 0ft.

2 Indoor temp. : 70°FDB, 60°FWB/inlet water temp. : 70°F/Equivalent piping length : 25ft, level difference : 0ft.

*The tested system EER and COP values reflect "full load" efficiency only and are the results from testing to the "Alternate Test Method" (ATM) guidelines provided by the U.S. Department of Energy (DOE) in the Federal Register / Vol. 74, No. 68 / Friday April 10, 2009 / Notices / Pages 16373 - 16377. All tested values surpass the minimum efficiency levels regulated in the DOE Code of Federal Regulation 10 CFR Ch. II § 431.97.

**There is no minimum efficiency defined in 10 CFR Ch. II § 431.97 for Water Cooled Packaged equipment greater than 135,000 Btu/hr.

Testing was performed at full load capacity with a ducted indoor unit configuration to determine only the Energy Efficiency Ratio (EER) and Coefficient Of Performance (COP) as specified from the DOE in the ATM guidelines. A VRV®-WIII system is a system that is constantly modulating its operation, via its intelligent Inverter Compressor Technology and Electronic Expansion Valves, to satisfy the ever changing load requirements of the buildings they serve. Although EER and COP are a common metric for comparing efficiencies, they do not fully qualify the expected performance as the majority of operating hours are in part load operation. However, at this time no official testing and rating program to quantify the part load efficiency (such as iPLV) of a VRV-WIII system is recognized by the DOE.



VRV-WIII Specifications

Triple module system

VRV-WIII - Unified Heat Pump and Heat Recovery			18-Ton		21-Ton	
Model	Name		RWEYQ216PTJU		RWEYQ252PTJU	
	Combination		3 x RWEYQ72PTJU		3 x RWEYQ84PTJU	
Performance	Cooling Capacity ¹	Btu/h	216,000		252,000	
	Rated Full Load EER*		15.3**		13.7**	
	Cooling Input Power	kW	12.6		16.8	
	Heating Capacity ²	Btu/h	243,000		283,500	
	Rated Full Load COP*		5.3**		4.7**	
	Heating Input Power	kW (Btu/h)	12.0 (40,944)		16.2 (55,274)	
	Power	V/Ph/Hz	208-230/3/60		208-230/3/60	
	Sound Pressure Level @ 3ft.	dB(A)	56		57	
Refrigerant Piping	System Configuration		Heat Pump	Heat Recovery	Heat Pump	Heat Recovery
	Liquid Pipe (Main Line)	in.	5/8	5/8	3/4	3/4
	Suction Gas Pipe (Main Line)	in.	N/A	1 3/8	N/A	1 3/8
	Discharge Gas Pipe (Main Line)	in.	1 3/8	1 1/8	1 3/8	1 1/8
	Vertical Pipe Length (if unit is below FCU)	ft.	164 (130)		164 (130)	
	Actual Pipe Length (Equivalent Length)	ft.	390 (459)		390 (459)	
	Total Pipe Length	ft.	980		980	
Connection Ratio	Standard Connectable Indoor Unit Ratio	%	50 - 130		50 - 130	
	Maximum Number of Indoor Units	Qty.	22		32	
Water Side	BPHE Inlet Pipe (Female Thread)	in.	3 x (1 1/4FPT)		3 x (1 1/4FPT)	
	BPHE Outlet Pipe (Female Thread)	in.	3 x (1 1/4FPT)		3 x (1 1/4FPT)	
	Drain Pipe (Female Thread)	in.	3 x (1/2FPS)		3 x (1/2FPS)	
	Maximum System Water Pressure (BPHE)	psi	285		285	
	Inlet Water Temperature Range (intermittent)	°F	59 - 113 (50)		59 - 113 (50)	
	Recommended Inlet Water Flow Rate per Module (min.)	gpm	16.4 ~ 39.5 (13.2)		16.4 ~ 39.5 (13.2)	
Unit	Weight	lbs.	3 x 330		3 x 330	
	Dimensions (H x W x D)	in.	39 3/8 x (30 3/4 x 3) x 21 11/16			
Electrical	Voltage Range (min.-max.)	V	187-253		187-253	
	Maximum Overcurrent Protection (MOP)	A	40 + 40 + 40		40 + 40 + 40	
	Minimum Circuit Amps (MCA)	A	22.4 + 22.4 + 22.4		22.4 + 22.4 + 22.4	
	Compressor Rated Load Amps (RLA)	A	11.6 + 11.6 + 11.6		15.4 + 15.4 + 15.4	
	Compressor Type		Daikin G-Type Scroll		Daikin G-Type Scroll	
Compressor	Compressor Set-up		1 INV + 1 INV + 1 INV		1 INV + 1 INV + 1 INV	
	Compressor Capacity Control	%	8 - 100		8 - 100	

1 Indoor temp. : 80°FDB, 67°FWB/inlet water temp. : 85°F/outlet water temp. : 95°F Equivalent piping length : 25ft, level difference : 0ft.

2 Indoor temp. : 70°FDB, 60°FWB/inlet water temp. : 70°F/Equivalent piping length : 25ft, level difference : 0ft.

*The tested system EER and COP values reflect “full load” efficiency only and are the results from testing to the “Alternate Test Method” (ATM) guidelines provided by the U.S. Department of Energy (DOE) in the Federal Register / Vol. 74, No. 68 / Friday April 10, 2009 / Notices / Pages 16373 – 16377. All tested values surpass the minimum efficiency levels regulated in the DOE Code of Federal Regulation 10 CFR Ch. II § 431.97.

**There is no minimum efficiency defined in 10 CFR Ch. II § 431.97 for Water Cooled Packaged equipment greater than 135,000 Btu/hr.

Testing was performed at full load capacity with a ducted indoor unit configuration to determine only the Energy Efficiency Ratio (EER) and Coefficient Of Performance (COP) as specified from the DOE in the ATM guidelines. A VRV®-WIII system is a system that is constantly modulating its operation, via its intelligent Inverter Compressor Technology and Electronic Expansion Valves, to satisfy the ever changing load requirements of the buildings they serve. Although EER and COP are a common metric for comparing efficiencies, they do not fully qualify the expected performance as the majority of operating hours are in part load operation. However, at this time no official testing and rating program to quantify the part load efficiency (such as iPLV) of a VRV-WIII system is recognized by the DOE.



VRV-WIII Installation Space

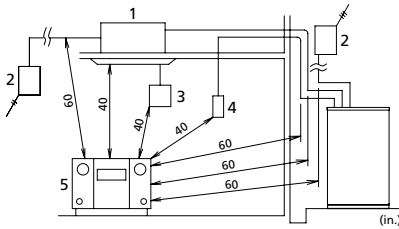

1. Indoor unit
2. Branch switch, overcurrent breaker
3. Remote controller
4. Cool/heat selector
5. Personal computer or radio

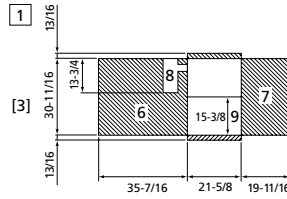

1. In case of a single installation [inch.]
2. In case of multiple unit installation [inch.]
3. Top view
4. Side view
5. Condensing unit
6. Service Space (front side)

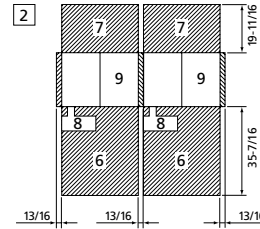

7. Service Space (back side)
8. Space for installing water piping secure enough space for removing the front panel.
9. Ventilation Space above the area () of the condensing unit.
10. Secure spaces in the front, back and top sides as same as the case of single installation.

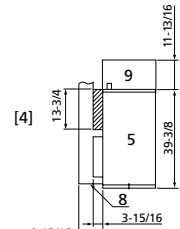

VRV-WIII Accessories

Branch Selector Units (for use with heat recovery configuration)

Model Name			BSVQ36PVJU	BSVQ60PVJU	BSVQ96PVJU
Power Supply		V/ph/Hz	208-230/1/60		
Total Capacity Index of Connectable Indoor Units			Less than 36	Less than 60	Less than 96
Number of Connectable Indoor Units			Max. 5	Max. 8	Max. 8
Casing			Galvanized Steel Plate		
Dimensions (H x W x D)		in.	8 1/8 x 15 1/4 x 12 13/16	8 1/8 x 15 1/4 x 12 13/16	8 3/16 x 15 5/16 x 12 7/8
Sound Absorbing Thermal Insulation Material			Foamed Polyurethane, Frame Resisting Needle Felt	Foamed Polyurethane, Frame Resisting Needle Felt	Foamed Polyurethane, Frame Resisting Needle Felt
Piping Connections	Indoor Unit	Liquid Pipes	in. \varnothing 3/8 (Braze) ¹	\varnothing 3/8 (Braze)	\varnothing 3/8 (Braze)
		Gas Pipes	in. \varnothing 5/8 (Braze) ¹	\varnothing 5/8 (Braze) ²	\varnothing 7/8 (Braze)
	Outdoor Unit	Liquid Pipes	in. \varnothing 3/8 (Braze)	\varnothing 3/8 (Braze)	\varnothing 3/8 (Braze)
		Suction Gas Pipes	in. \varnothing 5/8 (Braze)	\varnothing 5/8 (Braze) ²	\varnothing 7/8 (Braze)
	Discharge Gas Pipes	in. \varnothing 1/2 (Braze)	\varnothing 1/2 (Braze) ²	\varnothing 3/4 (Braze)	
Weight		lbs.	26	26	33



Note:

- ¹ In case of connecting with a 07-18 type indoor unit, match to the size of field pipe using the attached pipe. (Connection between the attached pipe and the field pipe must be brazed.)
- ² In case of connecting with indoor unit capacity index 54 or more and 60 or less, match the size of the field pipe using the attached pipe. (Connection between the attached pipe and the field pipe must be brazed.)

VRV-WIII Accessories









Model Name		RWEYQ72PTJU	RWEYQ144PTJU	RWEYQ216PTJU
Cool/Heat Selector (requires ABC terminal kit)		RWEYQ84PTJU	RWEYQ168PTJU	RWEYQ252PTJU
Fixing box		KRC19-26A6		
Distribution piping		KJB111A		
REFNET® header	KHRP25M33H (Max. 8 branch) KHRP26M22H (Max. 4 branch) KHRP26M33H (Max. 8 branch)	KHRP25M33H (Max. 8 branch)	KHRP25M72H (Max. 8 branch)	KHRP25M33H (Max. 8 branch)
		KHRP26M22H (Max. 4 branch)	KHRP26M33H (Max. 8 branch)	KHRP26M72H (Max. 8 branch)
REFNET® joint	KHRP25M22T KHRP25M33T KHRP26M22T KHRP26M33T	KHRP25M33H (Max. 8 branch)	KHRP25M72H (Max. 8 branch)	KHRP25M33H (Max. 8 branch)
		KHRP26M22H (Max. 4 branch)	KHRP26M33H (Max. 8 branch)	KHRP26M72H (Max. 8 branch)
Condensing unit multi connection piping kit (heat pump)		-	BHFP22MA56U	BHFP22MA84U
Condensing unit multi connection piping kit (heat recovery)		-	BHFP26MA56U	BHFP26MA84U
External control adapter for condensing unit		DTA104A62		

VRV Controls

Choosing the right controls

Unless it is controlled, managed and operated in an appropriate manner, a high-performing system will not be able to provide the energy-efficiency or comfort it claims. Promoting the systemization of control management not only improves efficiency, but also represents a number of possibilities in terms of convenience. Daikin's line up of intelligent controls gives the user the ability to address all needs in one package and one supplier: Daikin.

Daikin controls are optimized for VRV technology and offers highly scalable solutions for all applications and budgets. It also allows for lower cost alternatives to traditional energy management systems when centralized control is required.

Project Requirements	Daikin VRV Controls								
									
	BRC1E71 Navigation	BRC2A71 Simplified	DCS302C71 Centralized	DCS301C71 Unified	DCS601C71 Intelligent Touch	Intelligent Manager	BACnet Interface	LowWorks Interface	
Simple individual zone control	■	■							
Individual zone control with 7-day programmable scheduling	■								
Multi-zone control without scheduling functions			■						
Basic central point on/off control of all air handling units				■					
Advanced multi-zone control of small to medium size projects					■				
Advanced multi-zone control of large commercial projects						■	■	■	
Advanced multi-zone control with scheduling logic and calendar					■	■			
Automatic cooling/heating changeover for heat pump systems	■				■	■			
Single input batch shutdown of all connected air handlers			■	■	■	■	■	■	
Web browser control and monitoring via Intranet and Internet					■	■	■	■	
E-mail notification of system alarms and equipment malfunctions					■	■	■	■	
Multiple tenant power billing for shared condenser applications					■	■			
Temperature set-point range restrictions	■				■	■	■	■	
Graphical user interface based upon a PC platform						■			
Start/stop control of ancillary building systems ¹					■	■	■	■	
Daikin VRV integration with BACnet based automation systems							■		
Daikin VRV integration with LowWorks based automation systems								■	

¹ Requires one or more DEC102A51-US2 Digital Input/Output units.

- Native application or feature for this device.
- Dependent upon capabilities of the third party energy management system.

Controls that offer freedom to administrators

Freedom to control the air-conditioning system, via the Internet, from home or any other location with a PC. Should a malfunction occur, a notification is sent by e-mail to a cell phone or PC (any e-mail address specified by the user). This gives administrators the freedom to leave the room/building where the controller is located.

Intelligent touch Controller



DCS601C71

- 64 groups (128 indoor units) connectable
- Management of Daikin units and ancillary equipment
- Touch screen display
- Built-in Ethernet port, Web enabled (optional)
- Alarm e-mail function

Intelligent Manager III



IMP-128/256/512/768/1,024

- 1,024 indoor units (organized in up to 200 control groups)
- Management of Daikin units and ancillary equipment
- Operation on one master PC and one sub PC (sub PC option)
- Remote monitoring via the Web
- Alarm e-mail function

Connect VRV to your BMS via BACnet® or LonWorks® using Daikin's integrated control system solutions.

Compatible with BACnet and LonWorks, the two leading open network communication protocols, the interfaces offered by Daikin provides a seamless connection between VRV and your BMS.

LONWORKS®

LONWORKS Network Compatible Interface

- Interface for LonWorks networks
- Communication via LON protocol (twisted pair wire)
- 64 units connectable per interface
- Unlimited site size
- Quick, easy installation



BACnet®

BACnet is a registered trademark of ASHRAE.

BACnet Network Compatible Interface

- Interface for Building Management Systems
- Communication via BACnet protocol (BACnet/IP)
- 256 units connectable per BACnet gateway (with DAM411B51)
- Unlimited site size
- Quick, easy installation





WARNINGS:

- Always use a licensed installer or contractor to install this product. Do not try to install the product yourself. Improper installation can result in water or refrigerant leakage, electrical shock, fire or explosion.
 - Use only those parts and accessories supplied or specified by Daikin. Ask a licensed contractor to install those parts and accessories. Use of unauthorized parts and accessories or improper installation of parts and accessories can result in water or refrigerant leakage, electrical shock, fire or explosion.
 - Read the User's Manual carefully before using this product. The User's Manual provides important safety instructions and warnings. Be sure to follow these instructions and warnings.
- For any inquiries, contact your local Daikin sales office.



© 2011 Daikin Industries, Limited.

Daikin®, Daikin AC Absolute Comfort®, and its design, VRV® and REFNET™ are trademarks pending or registered trademarks of Daikin Industries, Limited. All rights reserved. LonWorks® and LON® are registered trademarks of Echelon Corporation. BACnet® is a Data Communication Protocol for Building Automation and Control Networks, developed under the auspices of the American Society of Heating, Refrigerating and Air-Conditioning Engineers (ASHRAE).



JMI-0107

Organization:
DAIKIN INDUSTRIES, LTD.
AIR CONDITIONING MANUFACTURING DIVISION

Scope of Registration:
THE DESIGN/DEVELOPMENT AND MANUFACTURE OF COMMERCIAL AIR CONDITIONING, HEATING, COOLING, REFRIGERATING EQUIPMENT, COMMERCIAL HEATING EQUIPMENT, RESIDENTIAL AIR CONDITIONING EQUIPMENT, HEAT RECLAIM VENTILATION, AIR CLEANING EQUIPMENT, MARINE TYPE CONTAINER REFRIGERATION UNITS, COMPRESSORS AND VALVES.



JQA-1452

Organization:
DAIKIN INDUSTRIES
(THAILAND) LTD.

Scope of Registration:
THE DESIGN/DEVELOPMENT AND MANUFACTURE OF AIR CONDITIONERS AND THE COMPONENTS INCLUDING COMPRESSORS USED FOR THEM.



All of the Daikin Group's business facilities and subsidiaries in Japan are certified under the ISO 14001 International standard for environmental management.

Daikin AC (Americas), Inc.
 1645 Wallace Drive, Suite 110
 Carrollton, TX 75006 USA
www.daikinac.com
info@daikinac.com
 866-4DAIKIN
 972-245-1510

PCVWUSE11-03C

Dealer Information

Daikin's products are subject to continuous improvements. Daikin reserves the right to modify product design, specifications and information in this brochure without notice and without incurring any obligations.